

Article number: 0110059

Description: Retaining ring JS 42x2  
Springsteel

## Measures

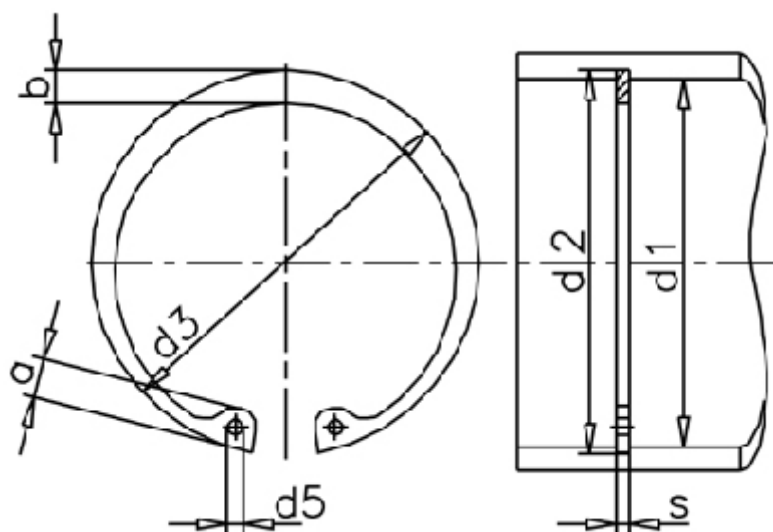

a max	= 6.7	Description	= JS 42	t	= 1.25
AN mm <sup>2</sup>	= 170	FN kN	= 28.4	tol	= 0.25
B	= 1.31	FRg kN	= 11.0	tol	= +0,90 -0,39
b	= 4.1	FR kN	= 58.5	tol	= -0.07
d1	= 42	g	= 2.0	Tong	= ZGJ-3
d2	= 44.5	m min	= 2.15	Weight kg/1000	= 5.6
d3	= 45.5	Nominal drive	= 3.8		
d5 min	= 2.5	s	= 2.00		